

| PART NO. | CARD THICKNESS |
|----------|----------------|
| RCP-06   | 1/16 (1.6)     |
| RCP-09   | 3/32 (2.4)     |

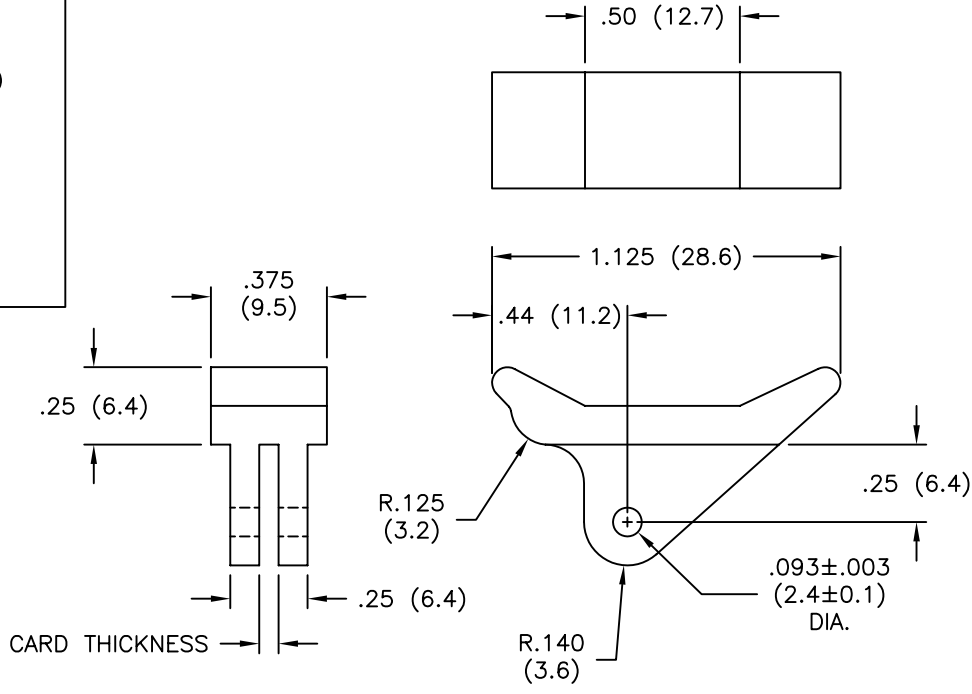
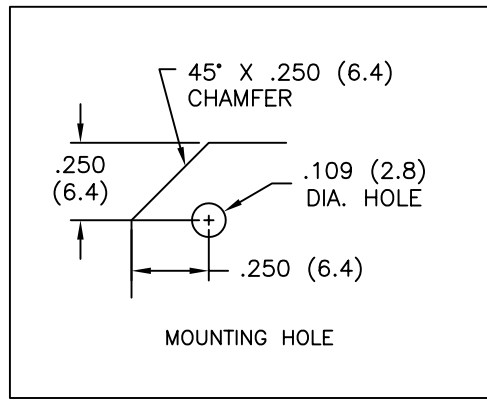

NOTES:

1. MATERIAL: NYLON 6/6 (RMS-48).
2. COLOR: WHITE.
3. INSTALLATION ROLL PIN NO. RRP-250, MATERIAL: PASSIVATED STAINLESS STEEL PER MIL-P-10971. COLOR: SILVER.  
 3/32 (2.4) DIA. X 1/4 (6.4) LONG, FURNISHED WITH EJECTORS.

|   |  |  |  |                     |  |
|---|--|--|--|---------------------|--|
| TITLE: CARD EJECTORS  |  | DWG IN IN (MM)   |  | FINAL               |  |
| FILE # RCP  |  | DWN: P.B.  |  | APP:                |  |
| MAT'L: SEE NOTES  |  | DT: 04-07-94   |  | DT:                 |  |
| RE: RICHCO, INC.  |  | RICHCO INC.<br>PO BOX 804238, CHICAGO, 60680<br>(773) 539-4060 |  | PART #<br>SEE TABLE |  |
| TOLERANCES UNLESS NOTED<br>.XX=±.010<br>.XXX=±.005<br>FRAC=±1/64<br>ANG=±1° |  |  |  | PRINT TYPE<br>CA    |  |

| REV | DESCRIPTION                          | ENGR | DATE     |
|-----|--------------------------------------|------|----------|
| D   | ADDED MOUNTING HOLE DETAIL, ECN #659 | SM   | 07.02.03 |
| C   | ADDED NOTE 3 (ECN #472)              | SM   | 09.26.02 |
| B   | CHANGED FILE NUMBER                  | SM   | 05.15.01 |
| A   | MAT'L COLOR WHITE WAS NATURAL        | J.L. | 3.17.99  |